

Shaft-End Washers

22270.0122



Product Description

Material

- Stainless steel 1.4305

Drawing

for countersunk screw
DIN EN ISO 2009
or DIN EN ISO 10642



Order information

d ₁	Dimensions			Art. No.
	d ₂ [mm]	s	[g]	
Stainless steel				
22	5.5	3.5	8.1	22270.0122

Application example

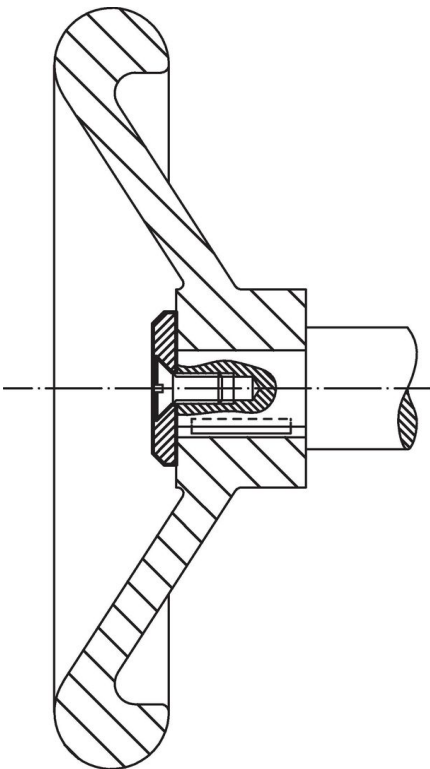

Compliance

RoHS compliant

Compliant according to Directive 2011/65/EU and Directive 2015/863.

Does not contain SVHC substances

No SVHC substances with more than 0.1% w/w contained - SVHC list [REACH] as of 27.06.2024.

Does not contain Proposition 65 substances

No Proposition 65 substances included.

<https://www.P65Warnings.ca.gov/>

Free from Conflict Minerals

This product does not contain any substances designated as "conflict minerals" such as tantalum, tin, gold or tungsten from the Democratic Republic of Congo or adjacent countries.