

Clamp Lock Pins · with button handle

22420.0110



Product Description

For rapid fastening, locking, adjusting, replacing, and securing in blind holes (H11) without additional locating bushings.

Quick and easy to release for connections which are made repeatedly. Flexible use because the balls are clamped between bolt and hole.

All versions are corrosion resistant. When using stainless steel 1.4542: high-strength, hardened, abrasion resistant pin with high load capacity.

Material

Pin part

- Stainless steel 1.4542, precipitation-hardened

Handle

- Aluminium, black similar to RAL 9005

Press button

- Case-hardened steel, nitrided, yellow similar to RAL 1016

Spring

- Stainless steel

Assembly

Simple H11 boreholes are sufficient.

Mounting:

- Press in the button and hold it down
- Insert the lifting pin
- Release the button (The button must be back in its original position)

Dismantling:

- Press in the button and hold it down.
- Remove the lifting pin.
- Release the button.

Operation

Clamp lock pins can be used in blind holes. The holding forces achieved in an H11 borehole depends on the material of the counterpart:

- Steel, hardened - min. 30 N
- Steel, soft - min. 120 N
- Stainless steel, soft - min. 120 N
- Al, aluminum alloy - min. 250 N

More information

Notes

Customized design on request.

The clamp lock pin must not be used for lifting loads.

Accessories

Can easily be fitted with retaining cable EH 22400.

Further products

- Retaining Cables

Drawing

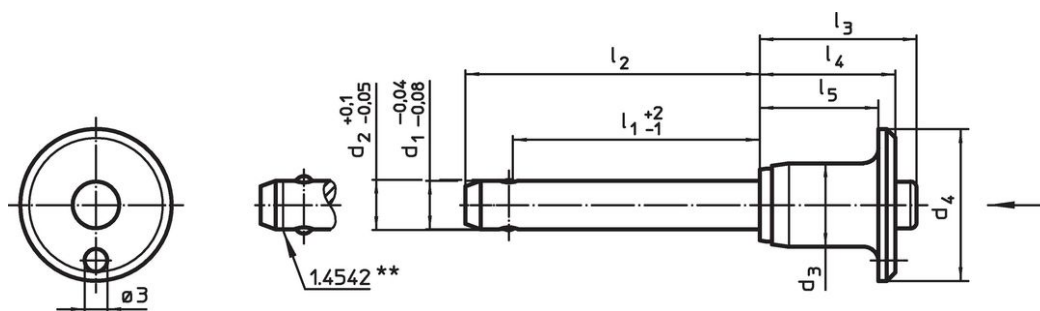

** Types from stainless steel 1.4542 with marking.

Order information

Dimensions										Holding force ¹⁾ min. Steel, soft [N]	Location hole H11 [mm]	Temperature		Weight [g]	Shearing resistance, two-shear ²⁾ min. [kN]	Art. No.	
d ₁	l ₁	d ₂	d ₃	d ₄	l ₂	l ₃	l ₄	l ₅	min.			max.	[°C]				
-0.04	+2	+0.1															
-0.08	-1	-0.05															
[mm]																	
Stainless steel																	
16	90	16.5	23.4	40	104.4	42.2	34.5	28.5	120	16	-30	150	242	257	22420.0110		

¹⁾ The holding force depends on the material of the counterpart - for further values see "operation".

²⁾ Shearing resistance similar to DIN 50141

Application example





Compliance

Non-RoHS compliant

Not compliant according to Directive 2011/65/EU and Directive 2015/863.

Contains SVHC substances >0,1% w/w

Contains lead - SVHC list [REACH] as of 27.06.2024.

Contains Proposition 65 substances



Lead can cause cancer and reproductive harm from exposure
<https://www.P65Warnings.ca.gov/>

Free from Conflict Minerals

This product does not contain any substances designated as "conflict minerals" such as tantalum, tin, gold or tungsten from the Democratic Republic of Congo or adjacent countries.