

Spoked Handwheels • light metal

24610.0031



Product Description

For all handwheels, the hub is machined, rim is turned and mirror-finished on all sides. The unmachined raw surfaces have been blasted clean. Together with their mirror-polished rim, these handwheels therefore present a finish which generally does not require additional lacquering.

Material

Axle part

- Steel, zinc-plated by galvanization

Handwheel

- Aluminium permanent-mould casting

Assembly

Shaft-end washers EH 22270. for axial fastening.

More information

Further products

- Shaft-End Washers
- Cylindrical Handles, rotating

Drawing

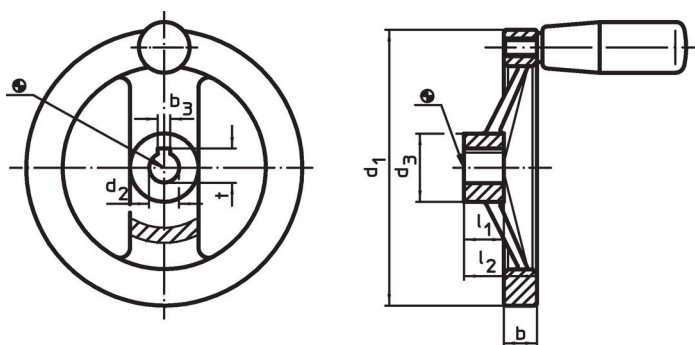

The orientation of the hub keyway may be different than shown in the drawing.

Order information

Dimensions						[g]	Art. No.
d ₁	d ₂ H7	d ₃	b	l ₁	l ₂ ~		
without hub keyway, without cylindrical handle							
200	20	42	20.5	24	45	876	24610.0031

Compliance

RoHS compliant

Contains lead - compliant according to exceptions 6a / 6b / 6c.

Contains SVHC substances >0,1% w/w

Contains lead - SVHC list [REACH] as of 27.06.2024.

Contains Proposition 65 substances



Lead can cause cancer and reproductive harm from exposure
<https://www.P65Warnings.ca.gov/>

Free from Conflict Minerals

This product does not contain any substances designated as "conflict minerals" such as tantalum, tin, gold or tungsten from the Democratic Republic of Congo or adjacent countries.