

## Index Plungers • threadless, weldable

22120.0806



### Product Description

Index plungers are used for indexing bores.

#### Material

##### Body

- Steel, blackened, weldable

##### Locking pin

- Steel, hardened

##### Knob

- Thermoplastic PA 6, black

#### Assembly

Attached by welding or glueing.

#### More information

#### Notes

Knob not removable.

#### Further products

- Locating Bushings, for index bolts and index plungers

### Drawing

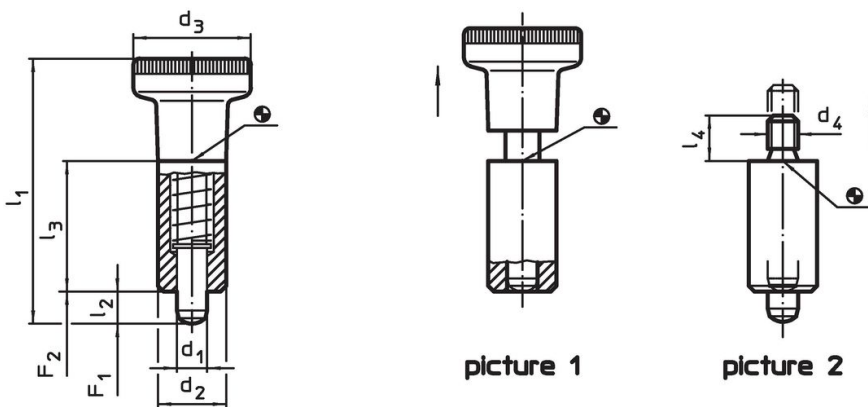

### Order information

Dimensions			Spring load <sup>1)</sup>			Temperature		Weight [g]	Art. No.		
d <sub>1</sub>	d <sub>2</sub>	d <sub>3</sub>	F <sub>1</sub>	F <sub>2</sub>	min.	max.					
-0.02 -0.05	h9		~	~			[°C]	[g]			
with knob – picture 1											
6	14	25	54.5	6	26	6.5	15	-30	80	40	22120.0806

<sup>1)</sup> statistical average value

## Application example

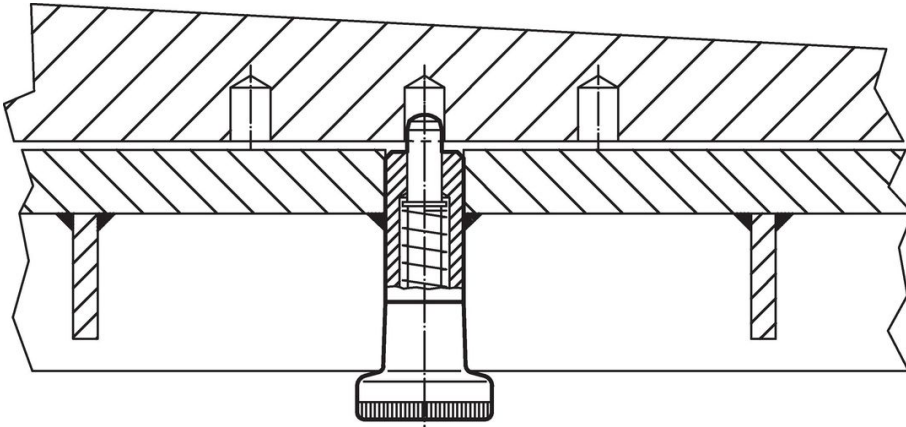

## Compliance

### RoHS compliant

Contains lead - compliant according to exceptions 6a / 6b / 6c.

### Contains SVHC substances >0,1% w/w

Contains lead - SVHC list [REACH] as of 27.06.2024.

### Contains Proposition 65 substances



Lead can cause cancer and reproductive harm from exposure  
<https://www.P65Warnings.ca.gov/>

### Free from Conflict Minerals

This product does not contain any substances designated as "conflict minerals" such as tantalum, tin, gold or tungsten from the Democratic Republic of Congo or adjacent countries.