

Grub Screws • ball-headed

22570.0424



Product Description

The ball-headed grub screws (EH 22570.) can be combined with plastic thrust pads (EH 22570.).

Material

- Stainless steel 1.4305

More information

Further products

- Thrust Pads, plastic

Drawing

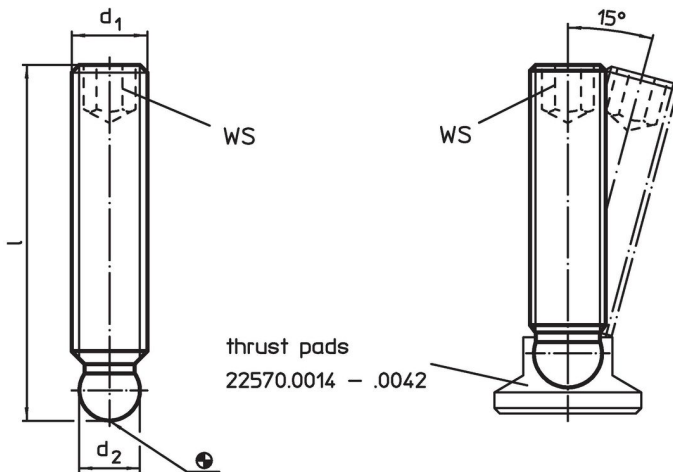

Order information

d ₁	Dimensions l [mm]	d ₂ +0.05	WS [mm]	 [g]	Art. No.
M8	50	6.1	4	14	22570.0424

Application example

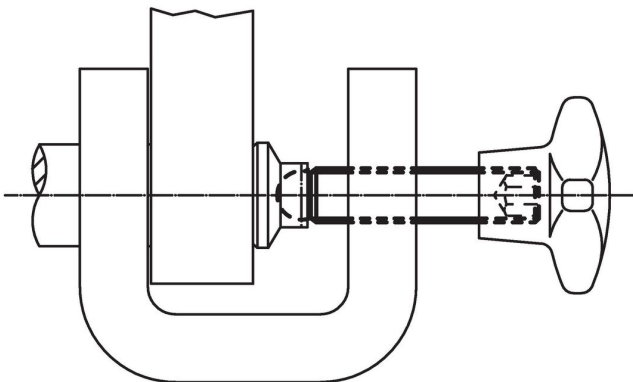

Compliance

RoHS compliant

Compliant according to Directive 2011/65/EU and Directive 2015/863.

Does not contain SVHC substances

No SVHC substances with more than 0.1% w/w contained - SVHC list [REACH] as of 27.06.2024.

Does not contain Proposition 65 substances

No Proposition 65 substances included.

<https://www.P65Warnings.ca.gov/>

Free from Conflict Minerals

This product does not contain any substances designated as "conflict minerals" such as tantalum, tin, gold or tungsten from the Democratic Republic of Congo or adjacent countries.