

Support Legs • protected against slipping

22593.1815



Product Description

The support legs are universally usable as adjustable legs.

In this version with a rubber cap, sensitive support surfaces are protected, and slipping is prevented.

The plate is screwed to the threaded pin and nut by a stainless steel fastening screw, and is also glued.

Material

Grub Screw

- Stainless steel 1.4305

Rubber cap

- Rubber, black

Lock nut

- Stainless Steel A2, ISO 4032

Pad

- Stainless steel 1.4301, vibratory ground

More information

Further products

- Support Legs

Drawing

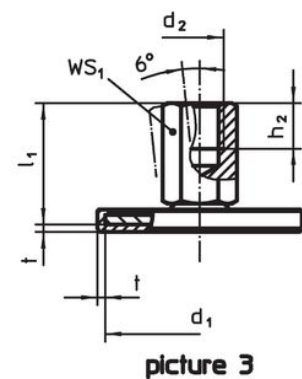
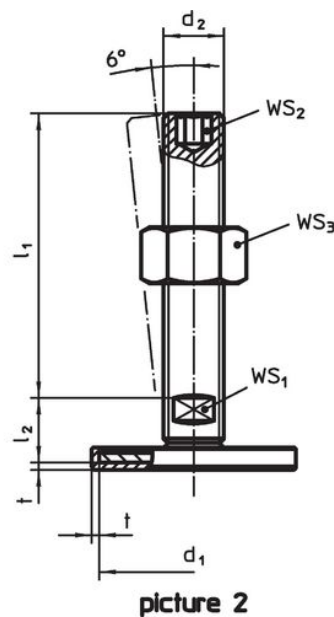
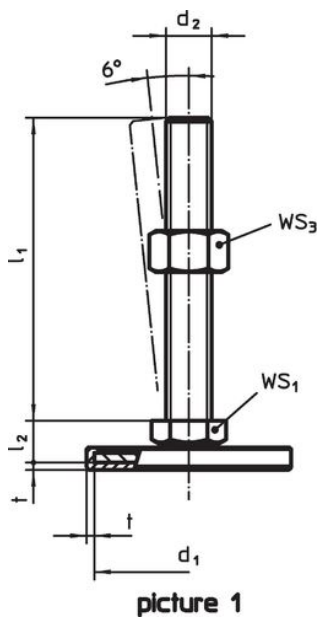

Order information

d ₁	d ₂	Dimensions			WS ₁ [mm]	WS ₃ [mm]	[g]	Art. No.
		l ₁ [mm]	l ₂	t				
with screw – picture 1, Stainless steel								
40	M8	63	11	1.5	17	13	56	22593.1815

Compliance

RoHS compliant

Compliant according to Directive 2011/65/EU and Directive 2015/863.

Does not contain SVHC substances

No SVHC substances with more than 0.1% w/w contained - SVHC list [REACH] as of 27.06.2024.

Does not contain Proposition 65 substances

No Proposition 65 substances included.

<https://www.P65Warnings.ca.gov/>

Free from Conflict Minerals

This product does not contain any substances designated as "conflict minerals" such as tantalum, tin, gold or tungsten from the Democratic Republic of Congo or adjacent countries.