

## Seating Pins • adjustable

22690.0644



### Product Description

The adjustable seating pins with induction hardened bearing surface can be used as seats and stops.

### Material

#### Seating Pins

- Heat-treated steel, tempered, quality 10.9, blackened / bearing surface induction hardened

#### Nut

- Heat-treated steel, tempered, quality 8.8 (ISO 4035), blackened

### Drawing

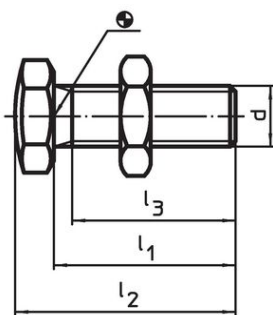

picture 1

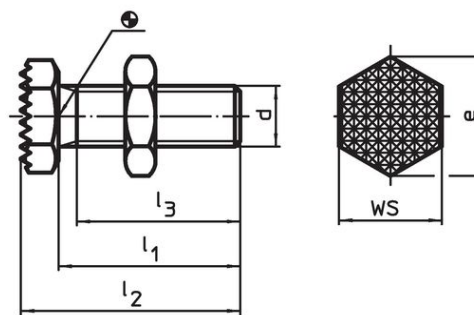

picture 2

### Order information

d	l <sub>1</sub> ±1.5	Dimensions			e	WS [mm]	 [g]	Art. No.
		l <sub>2</sub> ±1.5 [mm]	l <sub>3</sub> min.					
bearing surface ribbed – picture 2								
M24	50	64	40	41.6	36	308	22690.0644	

### Application example



### Compliance

#### RoHS compliant

Compliant according to Directive 2011/65/EU and Directive 2015/863.

#### Does not contain SVHC substances

No SVHC substances with more than 0.1% w/w contained - SVHC list [REACH] as of 27.06.2024.

#### Does not contain Proposition 65 substances

No Proposition 65 substances included.  
<https://www.P65Warnings.ca.gov/>

#### Free from Conflict Minerals

This product does not contain any substances designated as "conflict minerals" such as tantalum, tin, gold or tungsten from the Democratic Republic of Congo or adjacent countries.