

Positioning Sensors · pneumatical

22800.0010



Product Description

Used in jigs and fixtures as positioning control for pre-machined workpieces. Sensitivity accuracy is 0.015-0.075 mm, depending on the workpiece surface. Contact control is achieved through compressed air backwash and is indicated on the monitoring unit.

Material

Seating Pins

- Tool steel, hardened, ground

Seal

- PVC

Screw

- Steel, zinc-plated by galvanization, quality 4.8 (ISO 1207)

Plug-in nipple

- Brass

More information

Notes

Further information on request.

Further products

- Monitoring Units, for positioning sensors, pneumatic

Drawing

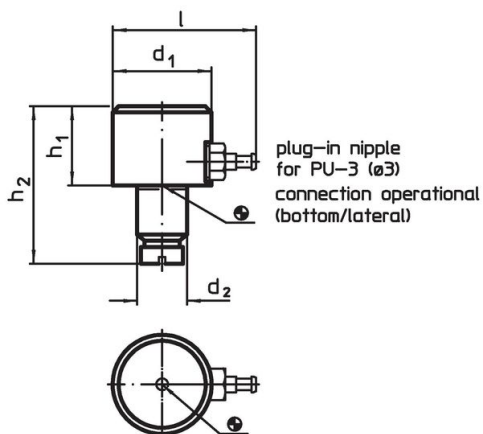

picture 1

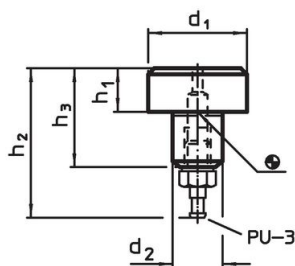

picture 2

Order information

Dimensions					[g]	Art. No.
d ₁	h ₁ h ₉	d ₂ n6 [mm]	h ₂	l		
bottom/lateral connection – picture 1						
16	13	8	27	28	24	22800.0010

Application example

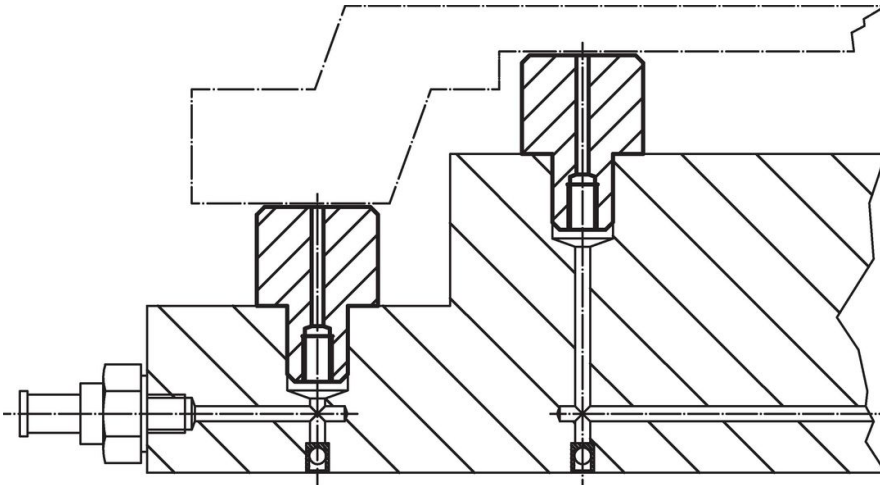

Compliance

RoHS compliant

Contains lead - compliant according to exceptions 6a / 6b / 6c.

Contains SVHC substances >0,1% w/w

Contains lead - SVHC list [REACH] as of 27.06.2024.

Contains Proposition 65 substances



Lead can cause cancer and reproductive harm from exposure
<https://www.P65Warnings.ca.gov/>

Free from Conflict Minerals

This product does not contain any substances designated as "conflict minerals" such as tantalum, tin, gold or tungsten from the Democratic Republic of Congo or adjacent countries.