

Standard Jaws • for vices
23231.0021



Product Description

These jaws are accessories for the clamping vice EH 23231..

Material

Thrust Pad

- Heat-treated steel, induction hardened

Jaw

- Case-hardened steel, case-hardened

More information

Notes

The delivery includes tightening screws.

Drawing

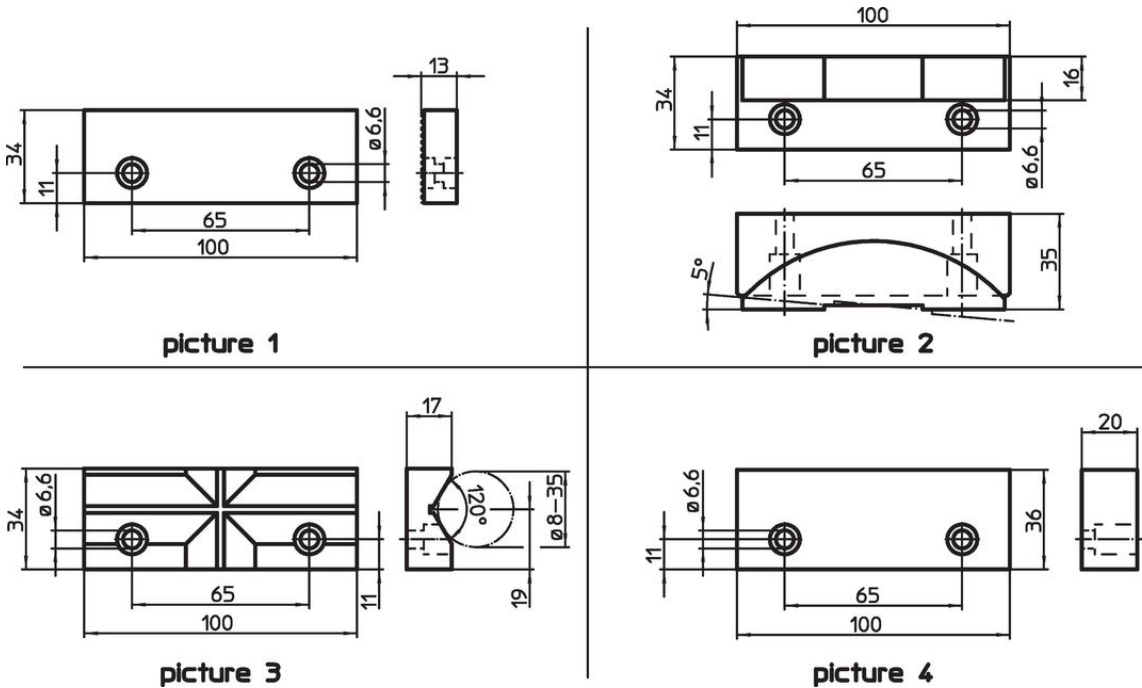

Order information

Nominal dimension [mm]	 [g]	Art. No.
floating jaw (body: of heat-treated steel, plunger: of heat-treated steel, induction-hardened) – picture 2		
100	810	23231.0021

Compliance

RoHS compliant

Compliant according to Directive 2011/65/EU and Directive 2015/863.

Does not contain SVHC substances

No SVHC substances with more than 0.1% w/w contained - SVHC list [REACH] as of 27.06.2024.

Does not contain Proposition 65 substances

No Proposition 65 substances included.

<https://www.P65Warnings.ca.gov/>

Free from Conflict Minerals

This product does not contain any substances designated as "conflict minerals" such as tantalum, tin, gold or tungsten from the Democratic Republic of Congo or adjacent countries.