

Star Grip Screws • Stainless steel

24690.0142



Product Description

Material

Handle

- Stainless steel 1.4301, dull blasted

Screw

- Stainless steel 1.4301

More information

Notes

Grip: Sheet-iron drawn. **Hub:** Butt-welded

Drawing

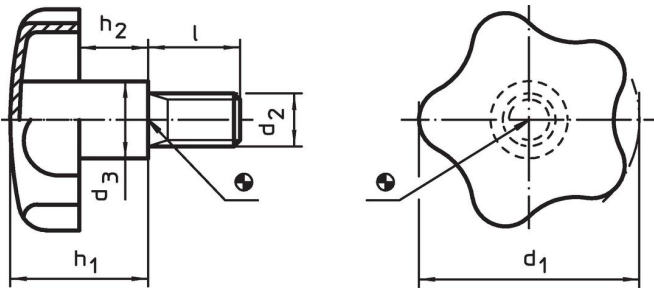

Order information

Dimensions						[g]	Art. No.
d ₁	d ₂	l	d ₃	h ₁ ~	h ₂ ~		
40	M8	30	14	24	12	55	24690.0142

Application example

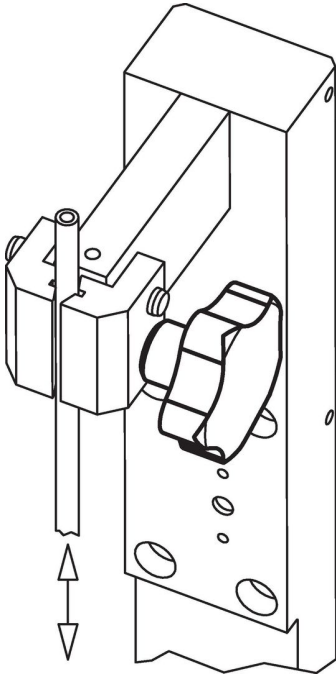

Compliance

RoHS compliant

Compliant according to Directive 2011/65/EU and Directive 2015/863.

Does not contain SVHC substances

No SVHC substances with more than 0.1% w/w contained - SVHC list [REACH] as of 27.06.2024.

Does not contain Proposition 65 substances

No Proposition 65 substances included.
<https://www.P65Warnings.ca.gov/>

Free from Conflict Minerals

This product does not contain any substances designated as "conflict minerals" such as tantalum, tin, gold or tungsten from the Democratic Republic of Congo or adjacent countries.