

Tapered Shaft Hubs · with lock nut

25050.0119



Product Description

It is a self-centering and non-floating tapered shaft hub in corrosion-protected design with a hexagon nut and a lock nut.

The rotational accuracy of the tapered shaft hubs is 0,03 mm.

By using tapered shaft hubs, all shaft-hub joints of machine elements such as sprocket wheels, gear wheels, belt pulleys, cams, levers etc. can be easily and efficiently established.

Material

External part

- Steel, zinc-plated by galvanization

Inner part

- Steel, nickel-plated

Nut

- Steel, nickel-plated

Assembly

The lock nut at the outer part facilitates locking of the shaft-hub joint if freely rotating shafts are involved. For mounting, a crescent wrench (thickness max. l_2-l_3) is used.

More information

References

Comply with mounting instructions, mounting examples, and technical data.

Drawing

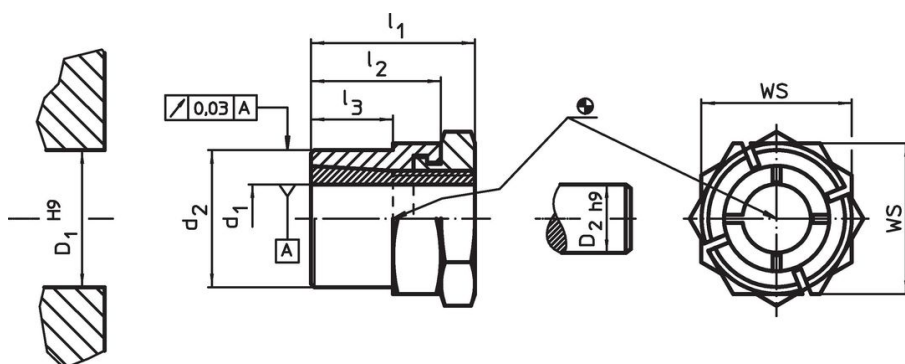

Order information

Dimensions					WS [mm]	Tightening torque of the nut T_A max. [Nm]	Transferable torque M max. [Nm]	Transferable axial load F_a max. [kN]	Surface pressure of shaft p_w max. [N/mm ²]	Surface pressure of hub p_N max. [N/mm ²]	Hub bore D ₁ H9 [mm]	Shaft diameter D ₂ h9 [mm]	Art. No.	
d ₁	d ₂	l ₁	l ₂	l ₃										
19	30	36	27	17	36	161	235	24.8	212	145	30	19	169	25050.0119

Accessories

	WS [mm]	Art. No.
special fork wrench		
	36	25050.0836

Application example



Compliance

RoHS compliant

Compliant according to Directive 2011/65/EU and Directive 2015/863.

Does not contain SVHC substances

No SVHC substances with more than 0.1% w/w contained - SVHC list [REACH] as of 27.06.2024.

Does not contain Proposition 65 substances

No Proposition 65 substances included.
<https://www.P65Warnings.ca.gov/>

Free from Conflict Minerals

This product does not contain any substances designated as "conflict minerals" such as tantalum, tin, gold or tungsten from the Democratic Republic of Congo or adjacent countries.